



 *Fabello Decor*®



2014



Лепные украшения из полиуретана

Есть такие вещи, без которых в доме не обойтись! Сантехника, бытовая техника, мебель. А есть то, что превращает помещение, в котором мы живем, в апартаменты. Если Вам приелась безликая непритязательность окружающей обстановки и Вы давно мечтаете о чем-нибудь гораздо более выразительном и стильном, то этот путеводитель для Вас.

Римская классика, классицизм, барокко, модерн - предстанут перед Вами в более чем 500 элементах лепного декора. Из современных коллекций лепнины, только производитель Fabello Decor может предложить покупателю такое многообразие и богатство ассортимента. Fabello Decor - самая крупная коллекция лепных украшений на мировом рынке.

Коллекция Fabello Decor - это лепнина из вспененного полиуретана, современного материала, пришедшего на смену гипсу и алебастру. Вспененный полиуретан был изобретен в России в 30 годы XX века, а в 60 - этот синтетический материал получил широкое распространение в Европе.

Легкую, но при этом столь же пластичную, как гипсовая, полиуретановую массу заливают в специально выточенные металлические формы, в результате чего получают изделия малого веса с прекрасно очерченным рельефом рисунка.

Прочный, экологически чистый, легкий полиуретан делает лепной декор максимально приспособленным для украшения интерьера любой сложности. Лепнина не желтеет со временем, не осыпается, не растрескивается, не теряет четкости рельефа, не собирает пыль. Ее можно подвергать влажной уборке. В отличие от мягкого полистирола, который также используется в производстве лепных украшений, она при любых условиях сохраняет форму.

Современный дизайн избегает однообразия, пусть даже классического. Традиционно белые лепные украшения сегодня все чаще подвергают той или иной покраске. Благодаря специальной грунтовке, поверхность декора Fabello Decor изначально подготовлена к ней. Для этой цели можно использовать любые водоземulsionные, акриловые, масляные краски.

Монтаж декоративных лепных украшений Fabello Decor достаточно прост, и может быть осуществлен домашним мастером.

Коллекция Fabello Decor включает в себя весь спектр декоративной лепнины, необходимый для воплощения законченного и гармоничного замысла. Это богатейший набор карнизов для оформления стыков стен и потолка, молдинги для украшения стен и потолка, розетки, оформляющие пространство вокруг люстры, пилястры, колонны, пьедесталы, а также множество других декоративных элементов, чья уместность в интерьере проверена временем.

С помощью лепного декора Fabello Decor можно воссоздать любую, историческую эпоху в отдельно взятом пространстве или сконструировать собственный новомодный стиль в духе современного эклектизма. Магическому очарованию классических форм найдется место в любой обстановке.

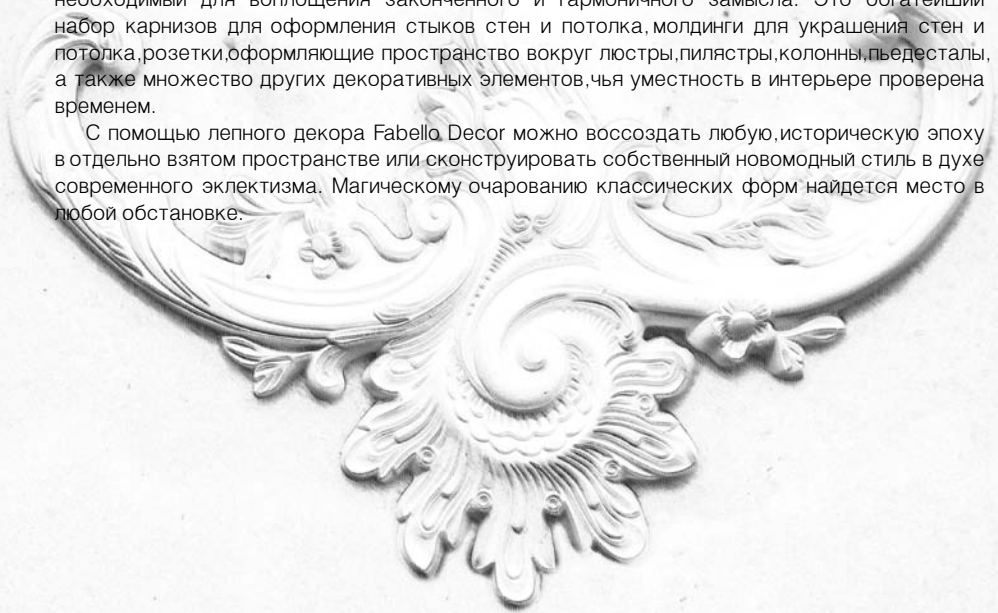

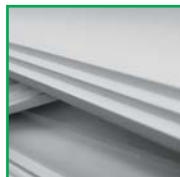

Карнизы с гладким профилем
4



Карнизы с орнаментом
8



Молдинги
17



Угловые элементы
23



Круговые бордюры
26



Потолочные розетки
28



Кессоны
34



Орнаменты
36



Консоли
38



Обрамление порталов
40



Пилястры
42



Колонны
46



Пьедесталы
52



Настенное панно
53



Обрамление дверных проемов
61



Ниши
65



Купола
68

Инструкция по монтажу лепного декора из полиуретана



1. Сделайте отметки карандашом на стене, чтобы определить местоположение карниза.



2. Используя ножовку, отрежьте карниз под углом 45 градусов.



3. Нанесите клей вдоль по краям обратной стороны карниза, а также на поверхность, которую будете клеить.



4. Соедините оба карниза вместе, чтобы их профили совпадали. Используйте специальный клей для стыковки изделий.



5. Перед тем как забить гвозди, убедитесь в ровности соединения.



6. С помощью ножа для замазки швов обработайте стыки карнизов.



7. Для шлифовки поверхности используйте наждачную бумагу.



8. Закройте стены и потолок тепп-лентой. Используя кисточку, покройте краской карниз.

Перед установкой элементов лепнины необходимо, чтобы изделия были адаптированы к помещению. Для этого следует их оставить на 24 часа в данном помещении.

Предварительно следует убедиться, что стены и потолок в местах монтажа лепнины сухие и чистые, для более надежной склейки их с полиуретаном.

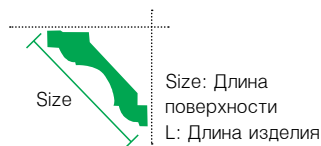

Карнизы - выступающие элементы внутренней и внешней отделки зданий, помещений, мебели. В архитектуре карниз отделяет плоскость крыши от вертикальной плоскости стены по выделенным горизонтальными линиями. Карниз из полиуретана - декоративный элемент, соединяющий шов между потолком и стенами.

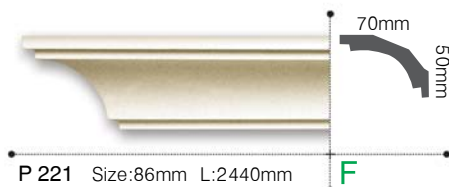

Карнизы с гладким профилем

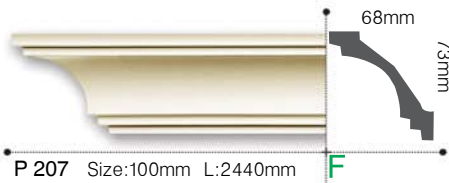
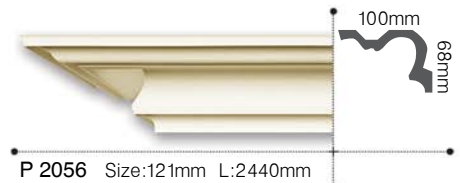
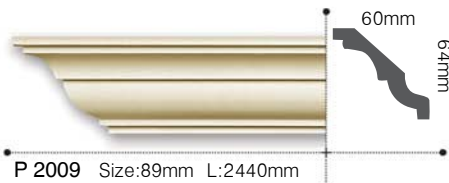
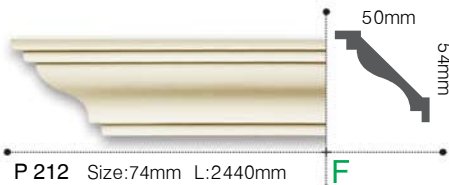
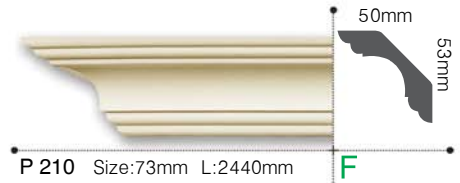
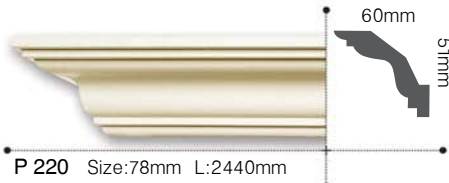

F - элемент имеет гибкий аналог

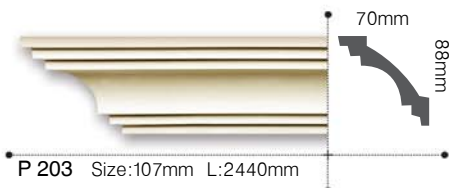
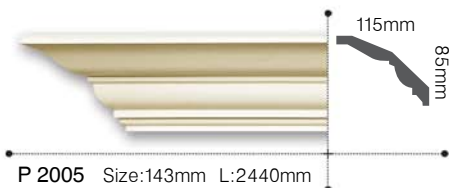

Карнизы с гладким профилем

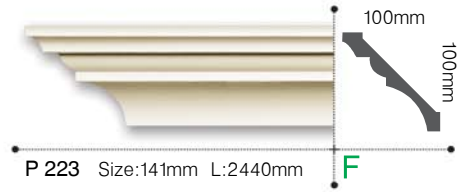

F - элемент имеет гибкий аналог

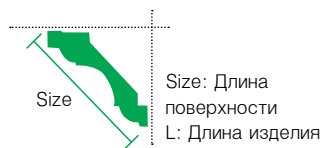

Карнизы не только оформляют периметр потолка, но и скрывают возможные неровности стыка потолка и стен. Каждый вид карниза или группа орнаментов позволяют создавать особое стилевое решение. Возможны комбинации карнизов гладких и с орнаментом. Их прочность гарантирует долгую службу, а возможность покраски поможет им удачно вписаться в интерьер.

В коллекции "Fabello Decor" - обширный ассортимент карнизов с различными видами орнаментов.



Карнизы с орнаментом



C 1044 Size:97mm L:2440mm



C 1084 Size:106mm L:2440mm



C 173 Size:101mm L:2440mm

F



C 1014 Size:89mm L:2440mm



C 1113 Size:103mm L:2440mm



C 176 Size:103mm L:2440mm

F



C 1079 Size:122mm L:2440mm



C 141 Size:83mm L:2440mm



C 128 Size:89mm L:2440mm



C 144 Size:129mm L:2440mm



C 152 Size:109mm L:2440mm



C 1001 Size:94mm L:2440mm

F

F - элемент имеет гибкий аналог



Карнизы с орнаментом



F - элемент имеет гибкий аналог



Карнизы с орнаментом





Карнизы с орнаментом



P 149 175×175mm L:2440mm



P 149 175×175mm L:2440mm



C 156 175×175mm L:2400mm

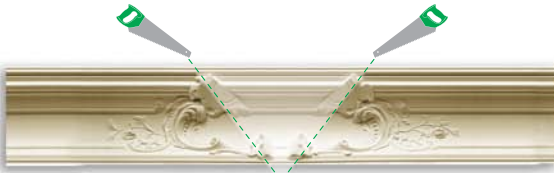

C 156 175×175mm L:2400mm



C 156 175×175mm L:2400mm



P 149 175×175mm L:2440mm



C 150 175×175mm L:2400mm

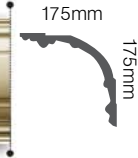

1210mm



C 156 175×175mm L:2400mm

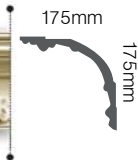

410mm



C 1093 120×120mm L:2440mm



C 1093 120×120mm L:2440mm



C 1091 120×120mm L:2440mm

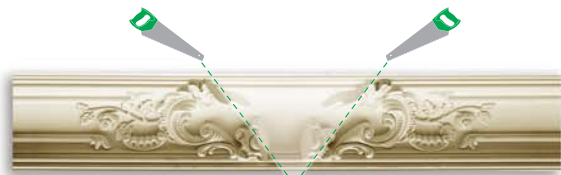

C 1091 120×120mm L:2440mm



C 1091 120×120mm L:2440mm



C 1093 120×120mm L:2440mm

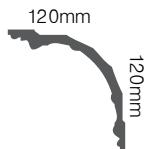

C 1092 120×120mm L:2440mm



870mm



C 1092 120×120mm L:2440mm

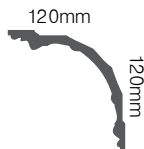

305mm

SIZE: Длина
L: поверхности
Длина изделия



Молдинги



F - элемент имеет гибкий аналог







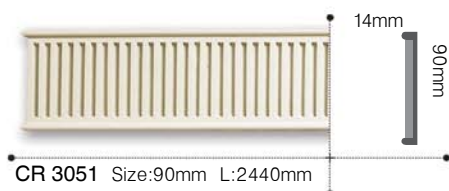
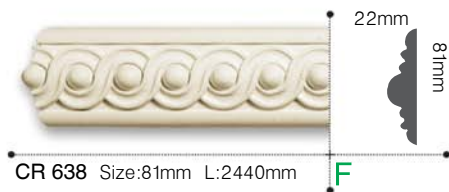



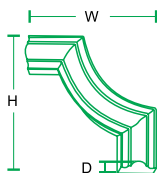

Угловые элементы и бордюры обычно используют для оформления плоскости потолка или стен определенным рельефом или узором. Оформленные таким образом стены или потолок приобретают изящные формы.

Лучшие образцы архитектуры элементов декора от древнегреческой классики до модерна используются для придания интерьерам насыщенной и завершенной композиции.

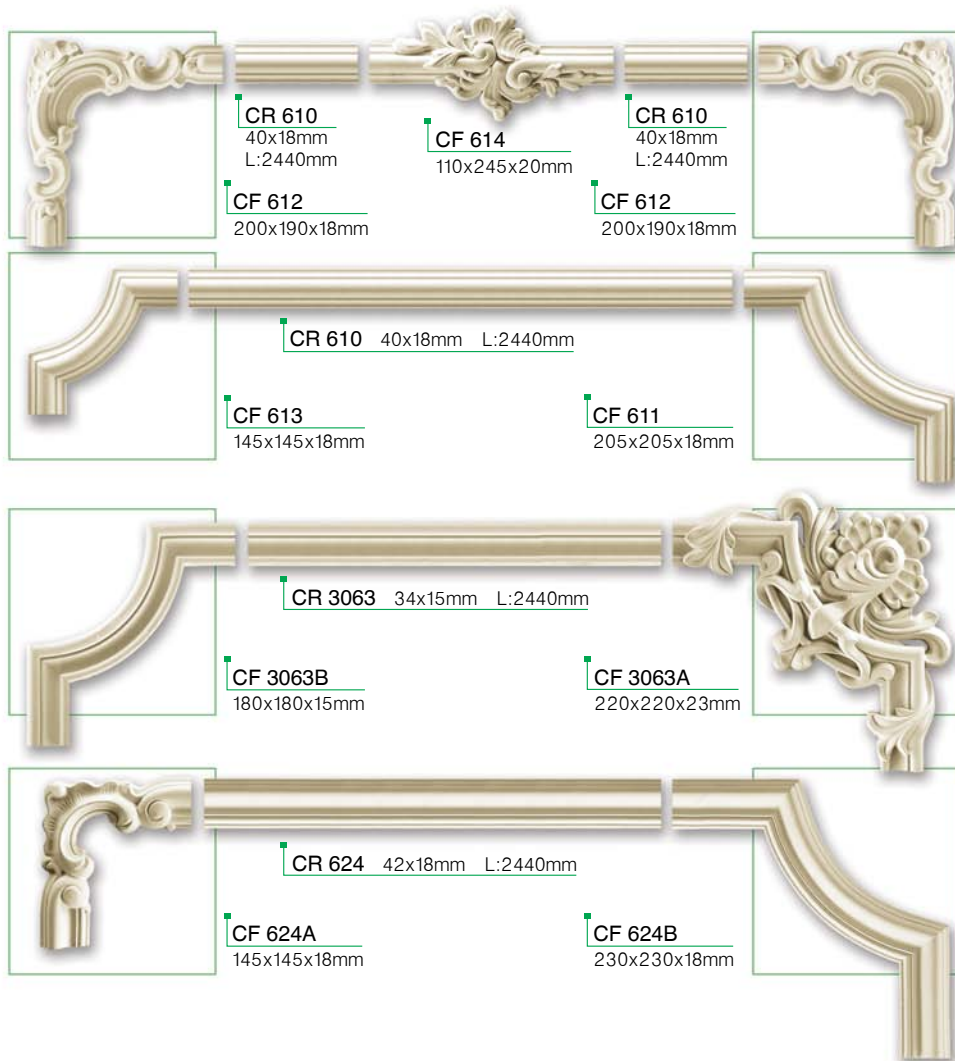

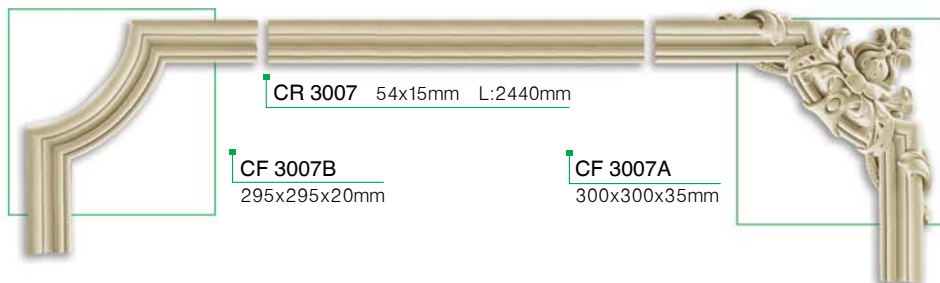
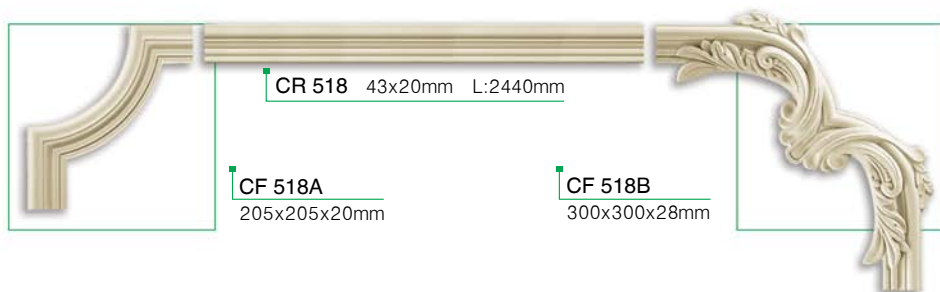



Круговые бордюры - изогнутые молдинги, которые используются для обрамления арочных проемов, нишевых пространств, оформления потолков, создания круговых рамок. С некоторыми из бордюров стыкуются молдинги.

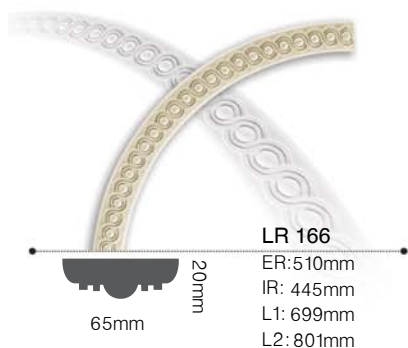
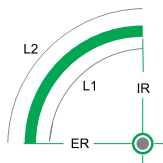
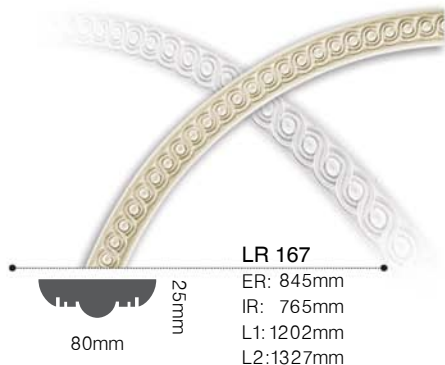



LR 3073/50	LR 3073/65
ER: 547mm	ER: 697mm
IR: 500mm	IR: 650mm
L1: 785mm	L1: 1021mm
L2: 859mm	L2: 1095mm



LR 3073F(R.L)/50

LR 3073F(R.L)/65
105x50x27mm



CR 3073 Size:49mm L:2440mm

17mm
49mm



LR 689/60	LR 689/70
ER: 662mm	ER: 762mm
IR: 600mm	IR: 700mm
L1: 942mm	L1: 1099mm
L2: 1039mm	L2: 1197mm



LR 689F(R.L)/60

LR 689F(R.L)/70
105x50x27mm



CR 689 Size:62mm L:2440mm

26mm
62mm

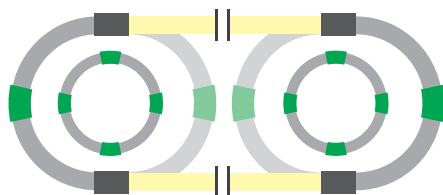

- LR 3073 / LR 689
- CR 3073 / CR 689
- LR 3073R / LR 689R
- LR 3073F / LR 689F

Традиционно потолочные розетки составляют центральную часть композиции потолка и оформляют пространство вокруг люстры.

Сегодня некоторые дизайнеры используют их в качестве орнамента на потолке или стене. Вместе с подобранными молдингами и карнизами придают потолку законченный вид.



R 4015
 ∅ 200mm
 H: 40mm



R 316
 ∅ 300mm
 H: 35mm



R 4016
 ∅ 300mm
 H: 32mm



R 371
 305x435mm
 H: 38mm



R 314
 315x600mm
 H: 45mm



R 318
 ∅ 335mm
 H: 45mm



R 312
 ∅ 400mm
 H: 32mm



R 4017
 ∅ 400mm
 H: 36mm



R 4030
 ∅ 400mm
 H: 45mm



R 4032
⌀ 400mm
H: 42mm



R 4033
⌀ 400mm
H: 49mm



R 350
⌀ 410mm
H: 24mm



R 303
⌀ 415mm
H: 45mm



R 4025
⌀ 430mm
H: 22mm



R 311
⌀ 435mm
H: 44mm



R 4037
⌀ 450mm
⌀ 100mm
H: 41mm



R 304
⌀ 460mm
H: 25mm



R 347
⌀ 460mm
H: 45mm



R 349

⌀ 460mm
H: 36mm



R 4012

⌀ 475mm
H: 48mm



R 4038

⌀ 478mm
⌀ 100mm
H: 50mm



R 313

⌀ 482mm
H: 35mm



R 309

⌀ 495mm
H: 58mm



R 4022

⌀ 500mm
H: 55mm



R 4019

500x800mm
H: 31mm



R 310

⌀ 515mm
H: 32mm



R 4029
 Ø 520mm
 H: 35mm



R 345
 Ø 525mm
 H: 29mm



R 4031
 Ø 540mm
 H: 50mm



R 317
 Ø 560mm
 H: 55mm



R 348
 Ø 575mm
 H: 27mm



R 4039
 Ø 596mm
 Ø 100mm
 H: 48mm



R 306
 Ø 600mm
 H: 46mm



R 4023
 Ø 600mm
 H: 31mm



R 301
 Ø 605mm
 H: 71mm



R 305
 Ø 660mm
 H: 65mm



R 4006
 Ø 665mm
 H: 65mm



R 336
 Ø 667mm
 H: 20mm



R 337
 Ø 670mm
 H: 55mm



R 338
 Ø 687mm
 H: 51mm



R 4024
 Ø 720mm
 H: 61mm



R 361
 730x1080mm
 H: 25mm





R 335
⌀ 738mm
H: 49mm



R 308
⌀ 760mm
H: 45mm



R 120
⌀ 770mm
H: 41mm



R 307
⌀ 830mm
H: 52mm



R 302
⌀ 968mm
H: 79mm



R 4007
⌀ 1010mm
H: 65mm

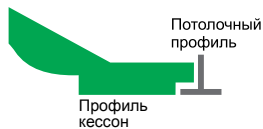

Кессоны - это квадратные или многоугольные углубления на потолке или внутренней поверхности арки, свода или потолка. Кессоны играют конструктивную роль, а также применяются для улучшения акустики помещений. Кессоны монтируются в подвесной гипсокартонный потолок и традиционно используются группой.



R 4009
604×604×40mm



R 4010
603×603×40mm



R 4013
603×603×48mm



R 4014
601×601×75mm



R 4041
609×609×73mm



R 4042
609×609×73mm



R 4043
609×609×84mm



R 4044
609×609×73mm



R 4045
607×607×76mm



R 4046
612×612×78mm



R 4047
609×609×73mm



R 4048
614×614×79mm



R 4049
609×609×76mm



R 4050
603×603×40mm

Многие дизайнеры используют эти украшения на основе сочетания, комбинации, для создания более богатых, наполненных жизнью эффектов и эстетики.

Ощутите удивительную разницу, используя немного воображения.



A 620
Ø 60×10mm



A 373
Ø 63×10mm



A 621
65×65×8mm



A 320
Ø 80×13mm



A 328
89×89×12mm



A 118
95×80×40mm



A 319
Ø 95×15mm



A 324
100×100×20mm



A 989
130×125×20mm



A 322
Ø 155×30mm



A 372
Ø 160×16mm



A 321
Ø 165×25mm



A 323
Ø 210×25mm



A 370
Ø 225×38mm



AW 6020L AW 6020R
125×40×9mm 125×40×9mm



AW 6039L AW 6039R
124×95×13mm 124×95×13mm



AW 6027L AW 6027R
125×80×13mm 125×80×13mm



AW 6074L AW 6074R
295×135×16mm 295×135×16mm



AW 6111L AW 6111R
260×126×15mm 260×126×15mm



AW 6018L AW 6018R
170×50×14mm 170×50×14mm



AW 6051
225×570×30mm



AW 6077
80×52×15mm



AW 6012
73×296×14mm



AW 6071
67×215×15mm



AW 6063
120×615×15mm

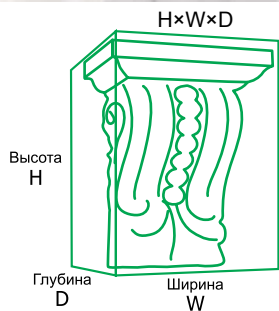

Консоли обычно используют для увеличения привлекательности колонн и потолочных участков. С их помощью завершают дизайнерское оформление на основе иллюзии дерева, гранита. Возможно также использование консолей в качестве полок и опор.



B 824
109×88×43mm



B 972
128×73×35mm



B 821
140×115×70mm



B 823
141×101×65mm



B 822
143×107×67mm



B 827M
152×100×54mm



B 837
168×109×60mm



B 964
168×114×70mm



B 978
185×77×151mm



B 960
189×116×85mm



B 966
191×185×98mm



B 965
206×91×76mm



B 957
212×120×47mm



B 835
220×130×94mm



B 813
223×182×84mm



B 976
238×88×58mm



B 962
250×168×122mm



B 959
253×127×51mm



B 816
265×172×83mm



B 815
269×156×55mm



B 859
715×145×215mm



B 961
281×246×199mm



B 814
282×159×67mm



B 971
301×171×145mm



B 977
310×130×75mm



B 963
314×143×145mm



B 979
325×114×108mm



B 857
382×209×132mm

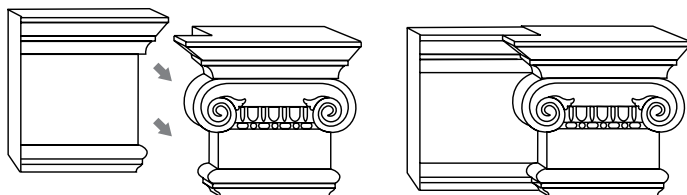
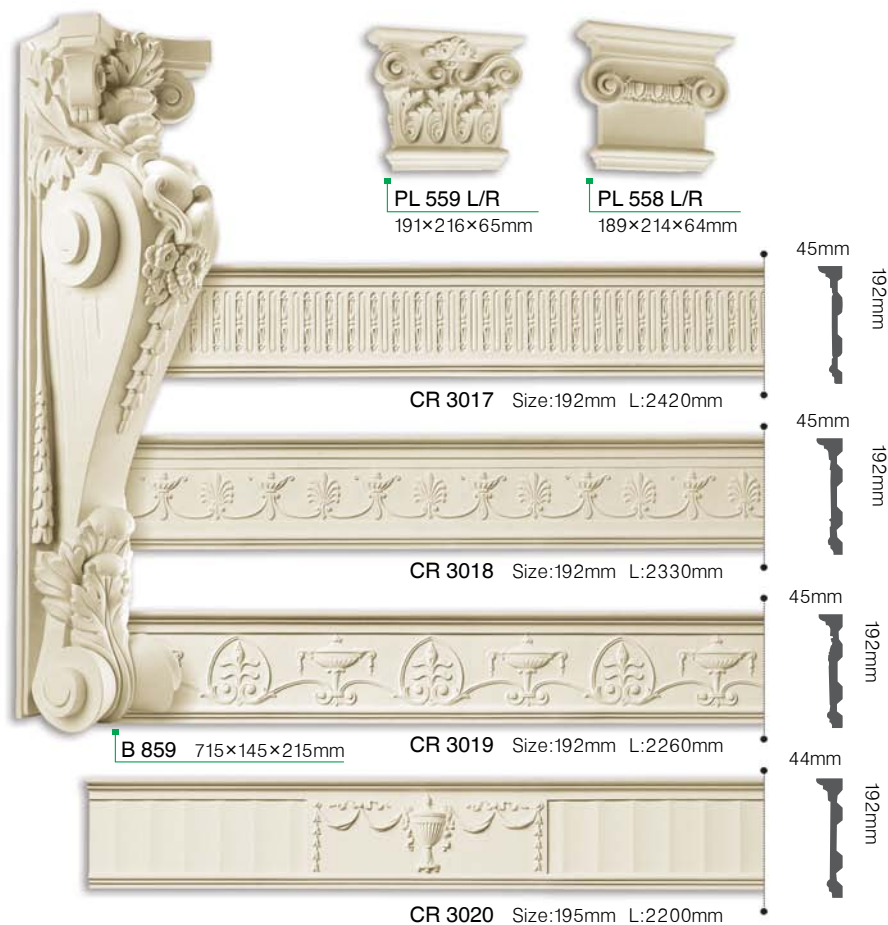



PL 559L + CR 3017 + PL 559R



PL 559L + CR 3018 + PL 559R



PL 558L + CR 3019 + PL 558R



PL 558L + CR 3020 + PL 558R

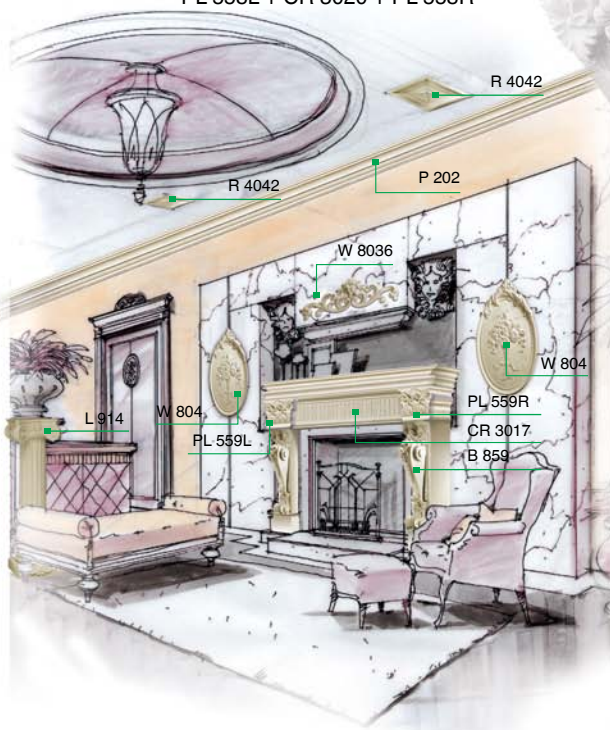

Капитель		PL 558 L/R				
		PL 559 L/R			PL 564	
		PL 554	PL 561	PL 564	PL 565	
	PL 551	PL 562	PL 563	PL 565	PL 567	PL 557
Тело	PL 550	PL 553	PL 573	PL 575	PL 576	PL 553×2
База	PL 552	PL 555	PL 574	PL 566	PL 566	PL 555×2

Пилястры предназначены для вертикального разделения плоскости на функциональные зоны. Могут использоваться парами в обрамлении дверей. При помощи пилястр можно избавиться от скучного, однообразного вида стены.

PL 557

345×419×95mm

PL 551

163×178×45mm

PL 554

145×225×50mm

PL 562

80×242×70mm

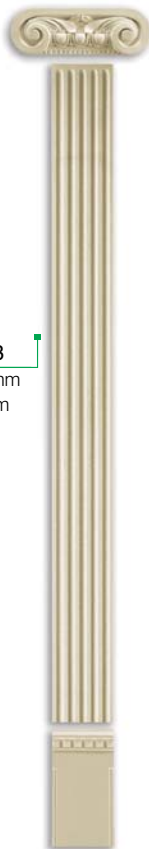
PL 550

 110×20mm
2000mm

PL 553

 135×20mm
2000mm

PL 553×2

 135×2×20mm
2000mm

PL 552

 255×110×30mm
E: 2418mm

PL 555

255×135×30mm

E: 2400mm

E: 2335mm

PL 555×2

255×135×2×30mm

E: 2600mm

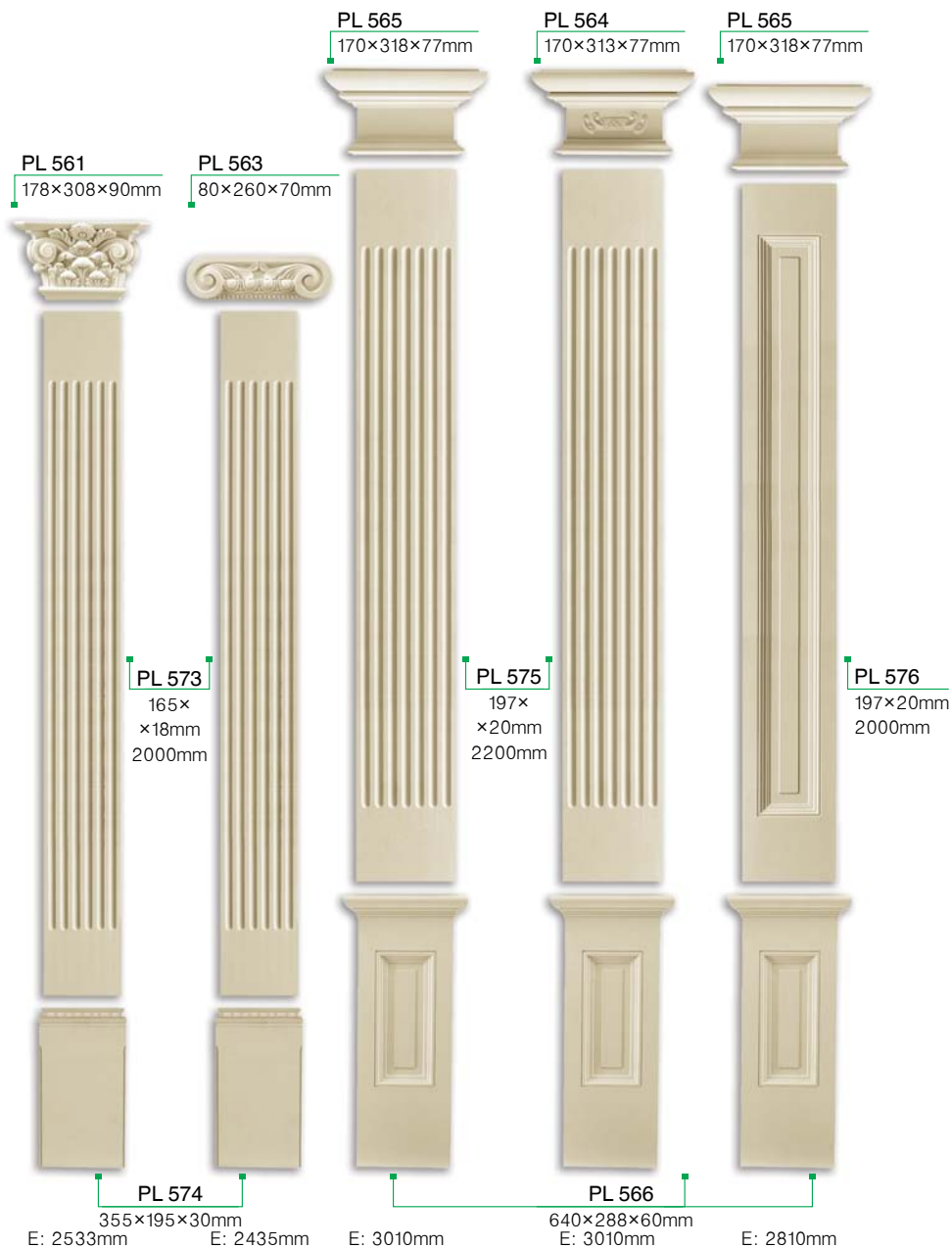

E - общая высота в сборе

PL 564

170×313×77mm



PL 567

212×212×30mm



PL 558 L/R

189×214×64mm



PL 559 L/R

191×216×65mm



PL 576

2000×197×20mm

PL 553

2000×135×20mm

PL 566

640×288×60mm

PL 555

255×135×30mm

E: 2810mm

E: 2852mm

E: 2444mm

E: 2446mm



CR 3017 Size:192mm L:2420mm



CR 3018 Size:192mm L:2330mm



CR 3019 Size:192mm L:2260mm



CR 3020 Size:195mm L:2200mm



PL 559L + CR 3018 + PL 559R
PL 55342 + PL 55542



PL 559L + CR 3017 + PL 559R



PL 558L + CR 3019 + PL 558R



PL 567 + CR 3019 + PL 567



PL 559 L/R
191×216×65mm



PL 558 L/R
189×214×64mm



PL 567
212×212×30mm



PL 555
255×135×30mm

Колонны используются как опорный элемент карниза, для оформления входа в здание или помещение. Могут быть применены в арочных конструкциях или проемах. Внутри помещения отделяют проходную часть от гостиной. Колонна состоит из капители, тела колонны и базы. Длину тела колонны можно варьировать в зависимости от высоты помещения путем укорачивания или дотачивания необходимой части.

Тело

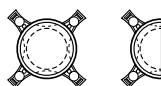
Капитель

Диаметр	Ширина	Высота	●	◐
∅ 120mm	230mm	85mm	L 9311 F	L 9321 H
∅ 150mm	265mm	105mm	L 9313 F	L 9323 H
∅ 180mm	300mm	115mm	L 9315 F	L 9325 H
∅ 200mm	360mm	125mm	L 9317 F	L 9327 H

Капитель



Диаметр	Ширина	Высота	●	◐
∅ 120mm	228mm	155mm	L 9312 F	L 9322 H
∅ 150mm	290mm	207mm	L 9314 F	L 9324 H
∅ 180mm	330mm	245mm	L 9316 F	L 9326 H
∅ 200mm	375mm	257mm	L 9318 F	L 9328 H

База

Диаметр	Ширина	Высота	●	◐
∅ 120mm	200mm	100mm	L 9309 F	L 9309 H
∅ 150mm	240mm	130mm	L 9310 F	L 9310 H
∅ 180mm	280mm	145mm	L 9319 F	L 9319 H
∅ 200mm	310mm	160mm	L 9320 F	L 9320 H

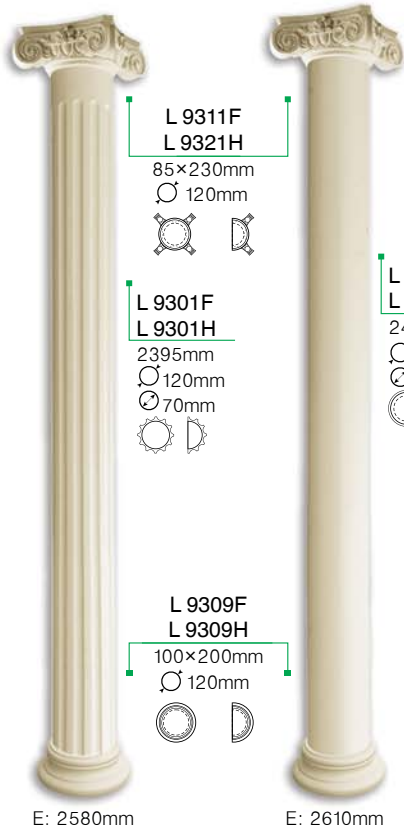

Диаметр	● Рифленая	○ Гладкая
∅ 120mm	L 9301	L 9302
∅ 150mm	L 9303	L 9304
∅ 180mm	L 9305	L 9306
∅ 200mm	L 9307	L 9308
Высота	2395mm	2425mm



L 9311F
L 9321H
85×230mm
∅ 120mm

L 9301F
L 9301H
2395mm
∅ 120mm
∅ 70mm

E: 2580mm

E: 2610mm

L 9302F
L 9302H
2425mm
∅ 120mm
∅ 70mm



L 9312F
L 9322H
155×228mm
∅ 120mm

L 9301F
L 9301H
2395mm
∅ 120mm
∅ 70mm

L 9302F
L 9302H
2425mm
∅ 120mm
∅ 70mm



L 9309F
L 9309H
100×200mm
∅ 120mm

L 9309F
L 9309H
100×200mm
∅ 120mm

E: 2650mm

E: 2680mm



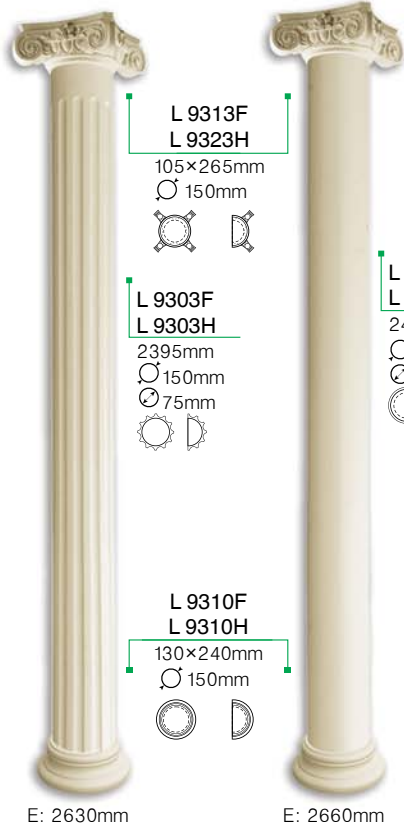



L 9315F
L 9325H

115×300mm
∅ 180mm



L 9305F
L 9305H

2395mm
∅ 180mm
∅ 105mm



L 9319F
L 9319H

145×280mm
∅ 180mm



E: 2655mm



L 9306F
L 9306H

2425mm
∅ 180mm
∅ 105mm



E: 2685mm



L 9316F
L 9326H

245×330mm
∅ 180mm



L 9305F
L 9305H

2395mm
∅ 180mm
∅ 105mm



E: 2785mm

L 9319F
L 9319H

145×280mm
∅ 180mm



E: 2815mm

L 9306F
L 9306H

2425mm
∅ 180mm
∅ 105mm



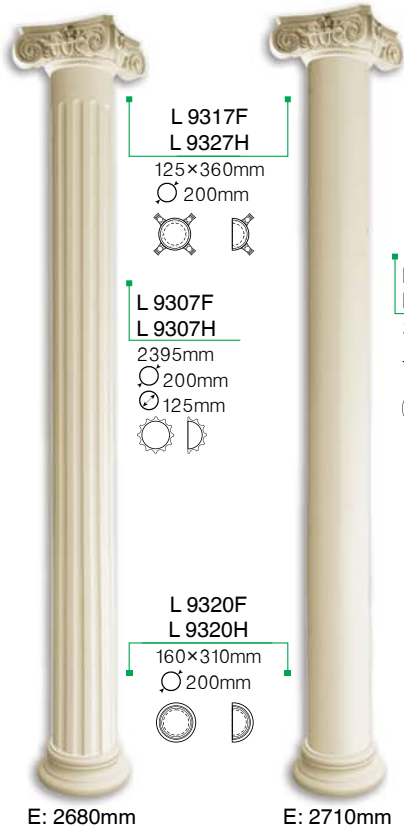

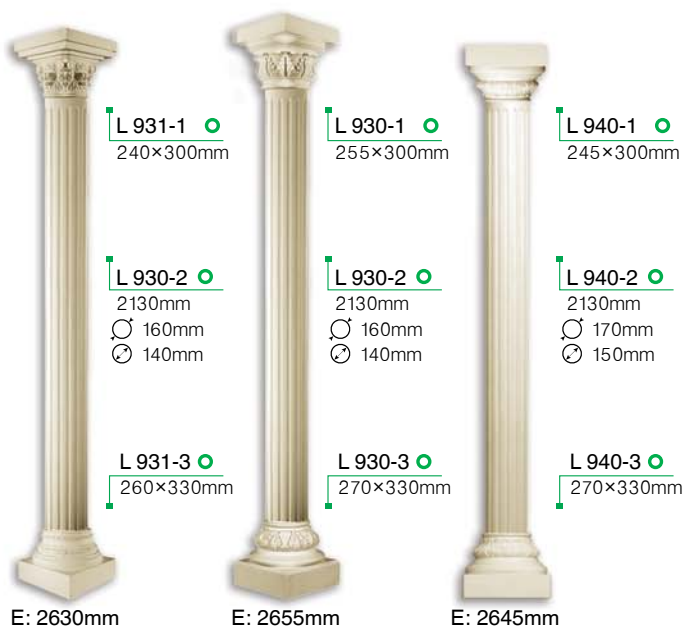

Укороченная колонна может быть использована как пьедестал для статуй, ваз и других декоративных деталей интерьера.

L 905

Высота: 705mm
Капитель: 260mm
Диаметр тела: 220mm
Основание: 300mm

L 925

Высота: 760mm
Капитель: 347mm
Диаметр тела: 320mm
Основание: 347mm

L 920

Высота: 762mm
Капитель: 300mm
Диаметр тела: 160mm
Основание: 300mm

L 919

Высота: 762mm
Капитель: 303mm
Диаметр тела: 160mm
Основание: 300mm

L 926

Высота: 762mm
Капитель: 355mm
Диаметр тела: 220mm
Основание: 360mm

L 924

Высота: 790mm
Капитель: 350mm
Диаметр тела: 220mm
Основание: 300mm

L 915

Высота: 908mm
Капитель: 250mm
Диаметр тела: 120mm
Основание: 250mm

L 904

Высота: 1050mm
Капитель: 310mm
Диаметр тела: 220mm
Основание: 322mm

L 914

Высота: 1170mm
Капитель: 330mm
Диаметр тела: 200mm
Основание: 310mm

Эта коллекция избавит вас от однообразной обстановки. У вас есть выбор средств для создания, желаемой атмосферы. Обычно эти элементы применяются на участках с фонтанами, источниками.

Имитация декоративного оформления из камня.



W 8011A

280×240×37mm



W 8011B

285×240×35mm



W 8011C

285×257×35mm



W 8011D

285×245×35mm



W 8010A

280×240×35mm



W 8010B

285×240×35mm



W 8010C

277×238×37mm



W 8010D

277×238×37mm



W 8044

Ø195



W 8049

369×1195×50mm



W 801

575×685×30mm



W 8048

307×994×21mm



D 597

550×550×16mm



D 598

220×550×16mm



W 705
80×300×12mm



W 690
390×535×30mm



W 8037
190×165×35mm

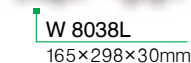

W 8038L
165×298×30mm

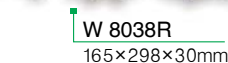

W 8038R
165×298×30mm



W 8028
130×330×30mm



W 8039
180×165×35mm

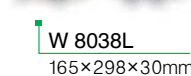

W 8038L
165×298×30mm

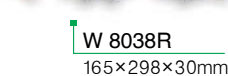

W 8038R
165×298×30mm



W 8025
125×550×37mm



W 8040
320×280×40mm



W 8041L
287×686×47mm

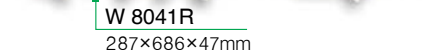

W 8041R
287×686×47mm



W 8021
155×290×25mm



W 703
220×410×35mm



W 988
130×126×18mm



W 8035
190×609×55mm



W 8019
230×387×35mm



W 984
160×117×30mm



W 8027
175×353×52mm



W 8033
170×100×25mm



W 986
125×210×40mm



W 8026S
140×230×30mm



W 8005
81×62×10mm



W 985

176×155×26mm



W 983

180×200×14mm



W 708

185×240×25mm



W 8029

225×416×52mm



W 8029S

160×270×35mm



W 707L

190×415×30mm



W 707R

190×415×30mm



W 8034

225×828×42mm



W 8022
360×795×50mm



W 8036
320×910×50mm



W 706
270×425×20mm



W 762
240×480×16mm



W 8023L W 8023R
332×80×23mm 332×80×23mm



W 8054
383×365×185mm



W 8055
376×365×185mm



W 805
1400×720×90mm



W 804
738×525×35mm



W 803
790×650×65mm



W 802
810×650×50mm

Обрамление дверных проемов



Данные украшения используются как обрамление дверных проемов. Это придает дверям классическое изящество. Лепные украшения предоставляют гибкость в подборе и комбинировании желаемых предпочтений. Они также используются для подчеркивания рельефа двери.

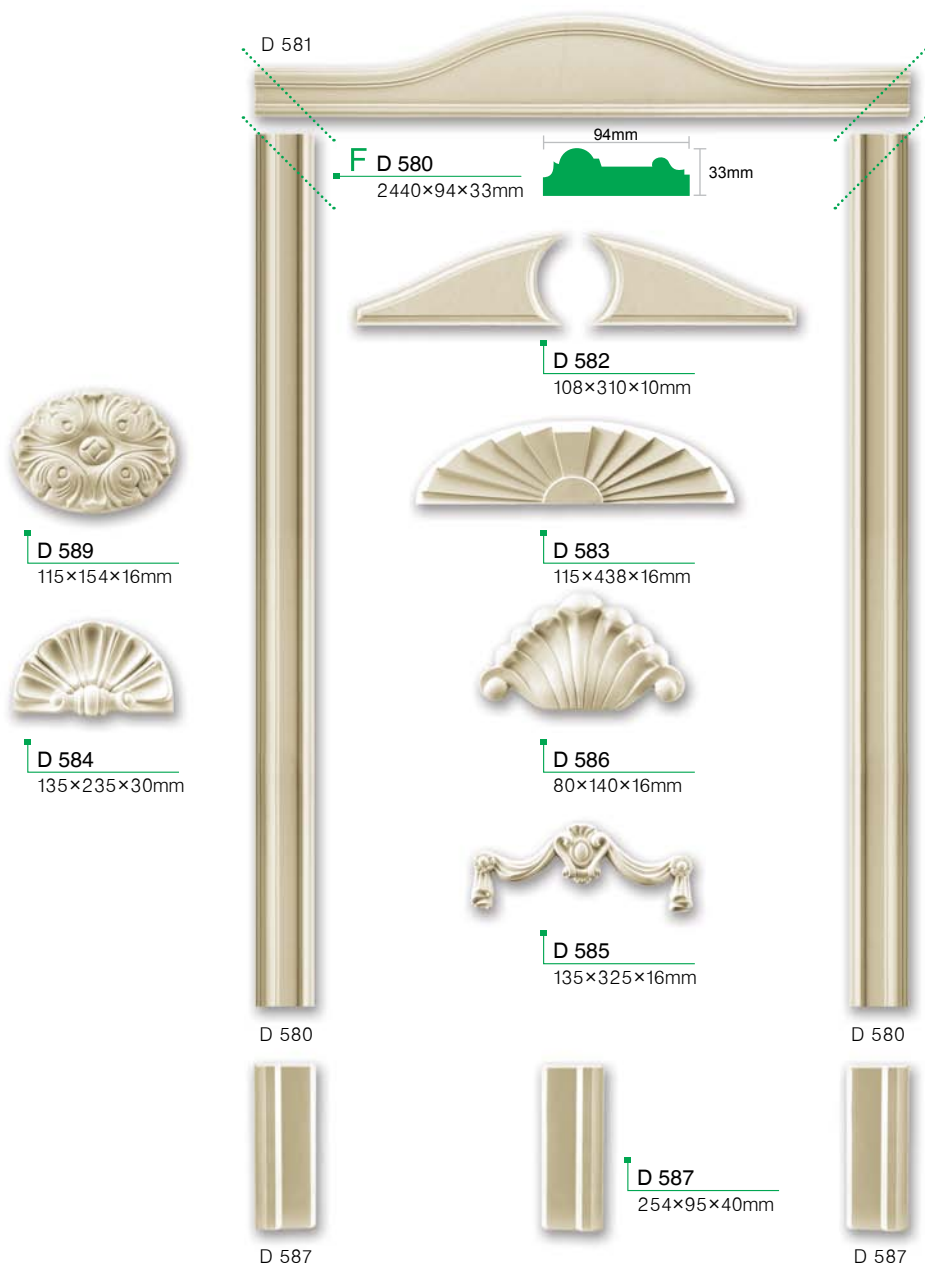

Обрамление дверных проемов



D 581 195×1250×35mm



D 581 + D 586



D 581 + D 583



D 581 + D 584 + D 600×2



D 581 + D 588×2



D 597
550×550×16mm



D 598
220×550×16mm



D 600
110×110×28mm



D 588
95×95×50mm



D 590
95×95×40mm

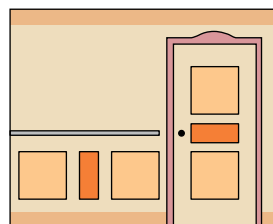
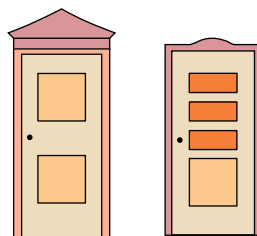

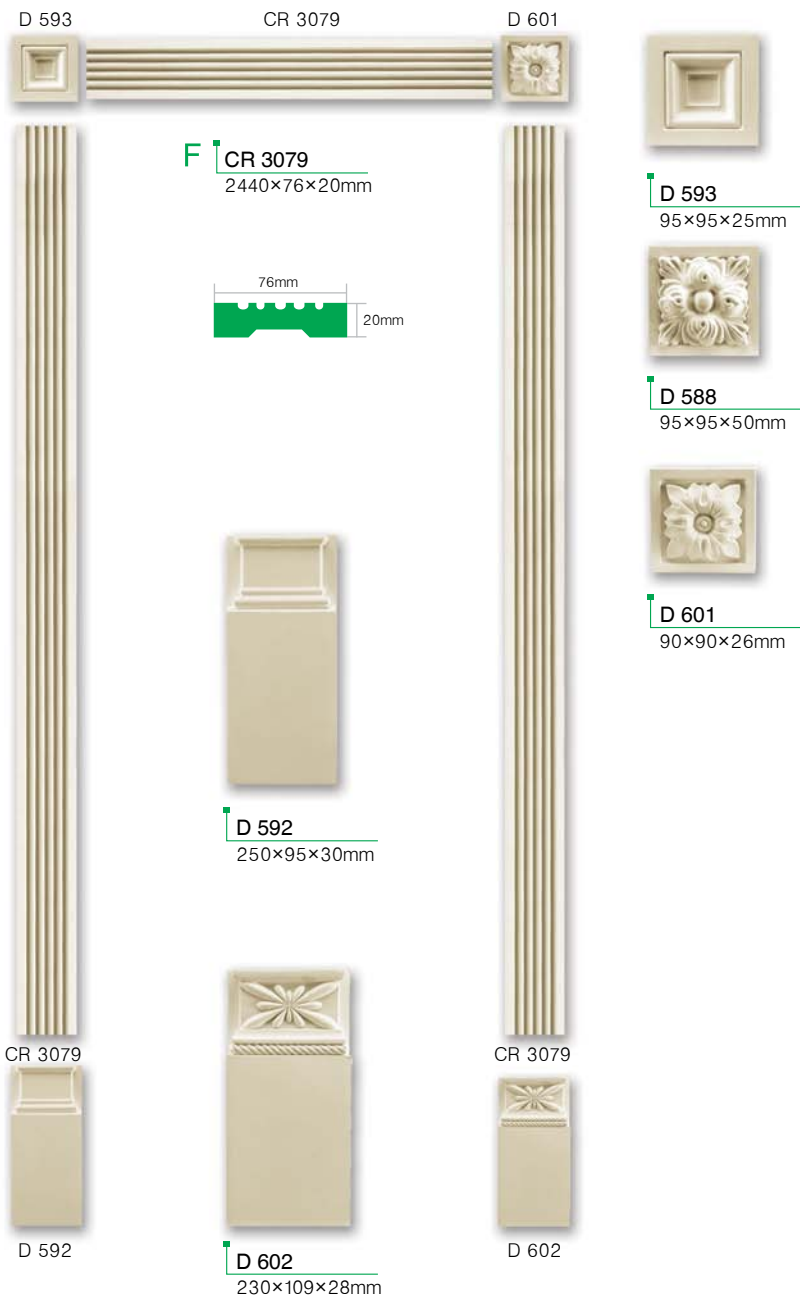

Ниши используются как встроенный элемент декора наружной и внутренней части дома. Пространство внутри ниши может быть заполнено бюстами, статуэтками, цветочными композициями, а также подсвечено.



N 732

A: 280mm
B: 260mm
C: 180mm
D: 380mm
E: 500mm
F: 85mm
G: 85mm
H: 50mm
I: 68mm



N 734

A: 640mm
B: 570mm
C: 450mm
D: 1015mm
E: 1320mm
F: 205mm
G: 335mm
H: 170mm
I: 330mm



N 731

A: 450mm
B: 440mm
C: 360mm
D: 645mm
E: 765mm
F: 85mm
G: 200mm
H: 125mm
I: 190mm



N 736

- A: 690mm
- B: 660mm
- C: 520mm
- D: 970mm
- E: 1145mm
- F: 120mm
- G: 280mm
- H: 210mm
- I: 275mm

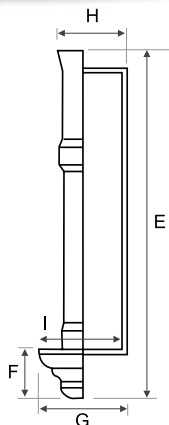
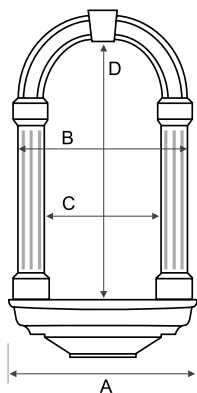

N 738

- A: 555mm
- B: 515mm
- C: 375mm
- D: 740mm
- E: 1000mm
- F: 190mm
- G: 242mm
- H: 145mm
- I: 223mm



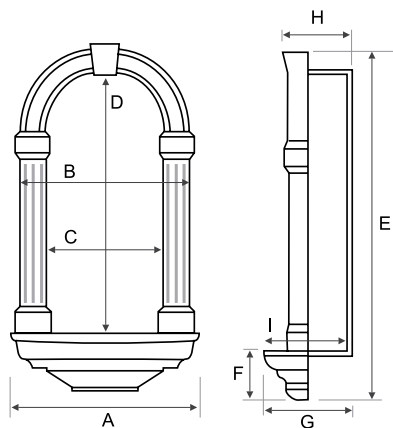

N 733-A

- A: 420mm
- B: 375mm
- C: 265mm
- D: 560mm
- E: 765mm
- F: 135mm
- G: 200mm
- H: 125mm
- I: 190mm



N 733

- A: 420mm
- B: 375mm
- C: 265mm
- D: 560mm
- E: 765mm
- F: 135mm
- G: 105mm
- H: 30mm



Потолочные купола разработаны для преобразования потолка, придавая приятную иллюзию глубины и объема. Изготовлены из уплотненного полиуретана и пластика.

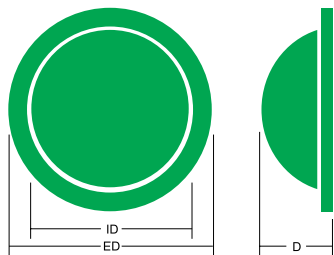

○ **DM 3501**
 ED: 1230mm
 ID: 980mm
 D: 230mm



○ **DM 3502**
 ED: 1230mm
 ID: 1080mm
 D: 200mm



○ **DM 3503**
 ED: 720mm
 ID: 570mm
 D: 125mm



DM 3504
ED: 1130mm
ID: 995mm
D: 215mm



DM 3505
ED: 1448mm
ID: 1220mm
D: 272mm



DM 3506
ED: 1225mm
ID: 1065mm
D: 215mm



○ DM 3507
ED: 1168mm
ID: 1005mm
D: 238mm



○ DM 3508
ED: 1130mm
ID: 930mm
D: 250mm



○ DM 3509
ED: 1530mm
ID: 1430mm
D: 90mm



DM 3510
ED: 950mm
ID: 820mm
D: 50mm



DM 3512
ED: 2020mm
ID: 1760mm
D: 190mm



DM 3513
ED: 2020mm
ID: 1760mm
D: 420mm

Карнизы с гладким профилем

P 132	7
P 133	7
P 134	5
P 135	F 6
P 136	6
P 149	7,15
P 201	F 5
P 202	F 7,41
P 203	6
P 205	F 5
P 207	F 5
P 208	F 5
P 210	F 5
P 212	F 5
P 214	F 5
P 219	F 5
P 220	5
P 221	F 4
P 222	F 4
P 223	F 7
P 224	F 4
P 232	6
P 2001	F 6
P 2002	4
P 2003	4
P 2004	7
P 2005	6
P 2006	7
P 2007	F 4
P 2008	6
P 2009	5
P 2010	F 4
P 2011	7
P 2012	4
P 2016	6
P 2024	7
P 2026	7
P 2031	7
P 2032	7
P 2048	6
P 2055	6
P 2056	5
P 2057	4
P 2072	F 6
P 2076	6
P 2119	F ● 4

Карнизы с орнаментом

C 101	14
C 102	14
C 104	F 11
C 109	12
C 110	14
C 117	14
C 118	14
C 119	14
C 121	12
C 122	12
C 123	12
C 124	F 12
C 125	12
C 126	13
C 127	14
C 128	9
C 129	F 8
C 138	11
C 140	F 14
C 141	9
C 143	12
C 144	9

Молдинги

CR 137	F 21
CR 153	F 20
CR 154	F 20
CR 155	F 20
CR 199	F ● 20
CR 200	F ● 22
CR 402	F 20
CR 403	F 21
CR 404	F 20
CR 405	F 19
CR 407	F 17
CR 512	F 21
CR 516	F 21

CR 518	F 18,24
CR 601	F 19
CR 602	F 20,25
CR 605	F 18,25
CR 607	F 18,25
CR 608	22
CR 610	F 18,23
CR 620	F 18,25
CR 622	F 19
CR 624	F 18,23
CR 632	F 22
CR 636	F 21
CR 638	F 21
CR 639	F ● 20
CR 642	19
CR 644	F 20
CR 646	F 22
CR 681	F 18
CR 683	F 19
CR 685	F 17
CR 686	F 17
CR 687	F 18
CR 688	F 19
CR 689	F 19
CR 3001	F 21
CR 3002	F 18
CR 3003	F 17
CR 3006	F 19
CR 3007	F 19,24
CR 3008	F 21
CR 3009	F 21
CR 3010	F 17,24
CR 3017	22,40,45
CR 3018	22,40,45
CR 3019	22,40,45
CR 3020	22,40,45
CR 3022	F 19
CR 3023	19
CR 3025	F 18
CR 3034	F 17
CR 3035	F 17
CR 3043	● 22
CR 3044	F 21
CR 3051	21
CR 3054	F 17
CR 3057	19
CR 3059	20
CR 3063	F 17
CR 3072	F 18,23
CR 3073	F 18
CR 3075	F 17
CR 3079	F 20,64
CR 3100	F 17
CR 3227	F 17
CR 3241	F ● 22
CR 3242	● 21
CR 3243	F ● 20

Угловые элементы

CF 518A	24
CF 518B	24
CF 602A	25
CF 605A	25
CF 605B	25
CF 607B	25
CF 611	23
CF 612	23
CF 613	23
CF 614	23
CF 620A	25
CF 624A	23
CF 624B	23

CF 3007A	24
CF 3007B	24
CF 3010A	24
CF 3010B	24
CF 3010C	24
CF 3010D	24
CF 3010E	24
CF 3063A	23
CF 3063B	23

Круговые бордюры

LR 166	26
LR 167	26
LR 168	26
LR 689F(R.L)/60	27
LR 689F(R.L)/70	27
LR 689/60	27
LR 689/70	27
LR 3073F(R.L)/50	27
LR 3073F(R.L)/65	27
LR 3073/50	27
LR 3073/65	27
LR 3601	26
LR 3602	26

Потолочные розетки

R 120	33
R 301	31
R 302	33
R 303	29
R 304	29
R 305	32
R 306	31
R 307	33
R 308	33
R 309	30
R 310	30
R 311	29
R 312	28
R 313	30
R 314	28
R 316	28
R 317	31
R 318	28
R 335	33
R 336	32
R 337	32
R 338	32
R 345	31
R 347	29
R 348	31
R 349	30
R 350	29
R 361	32
R 371	28
R 4006	32
R 4007	33
R 4012	30
R 4015	28
R 4016	28
R 4017	28
R 4019	30
R 4022	30
R 4023	31
R 4024	32
R 4025	29
R 4029	31
R 4030	28
R 4031	31
R 4032	29
R 4033	29

